

**Hotronix® FUSION™**

**40x50 cm**

**O P E R A T O R ' S M A N U A L**



Safety Instructions	2
Machine View	3
Connect the Hotronix® Fusion	4
Hotronix® Fusion Operating Instructions	5-14
Touch Screen Guide	5
Start Up / Shut Down	6
Operation Screen	7
Main Menu	8
Passwords	9
Auto On / Off Setup	10-11
Presets Setup	12
Adjusting Time, Date and Temperature	13
Printing / Pressing	14
Replacement Parts List	15
Location Guide	16
Hotronix® Fusion Electrical Schematic	17
CE-Certification	18
Terms of guarantee	19

## Important Safety Instructions

WHEN USING YOUR HEAT PRESS,  
BASIC PRECAUTIONS SHOULD ALWAYS BE FOLLOWED,  
INCLUDING THE FOLLOWING:

Read all instructions.

Use heat press only for its intended use.

To reduce the risk of electric shock, do not immerse the heat press in water or other liquids.

Never pull cord to disconnect from outlet, instead grasp plug and pull to disconnect.

Do not allow cord to touch hot surfaces, allow heat press to cool completely before storing.

Do not operate heat press with a damaged cord, or if the equipment has been dropped or damaged.

To reduce the risk of electric shock, do not disassemble or attempt to repair the heat press, take it to a qualified service person for examination and repair. Incorrect reassembly or repair could cause a risk of fire, electric shock, or injury to persons when the equipment is used.

Close supervision is necessary for any heat press being used by or near children. Do not leave equipment unattended while connected. Burns can occur when touching hot metal parts.

To reduce the likelihood of circuit overload, do not operate other high voltage equipment on the same circuit.

If an extension cord is necessary, then a 20 amperage rated cord should be used.

Cords rated for less amperage may overheat, care should be taken to arrange the cord so that it cannot be pulled or tripped over.

**SAVE THESE INSTRUCTIONS.**

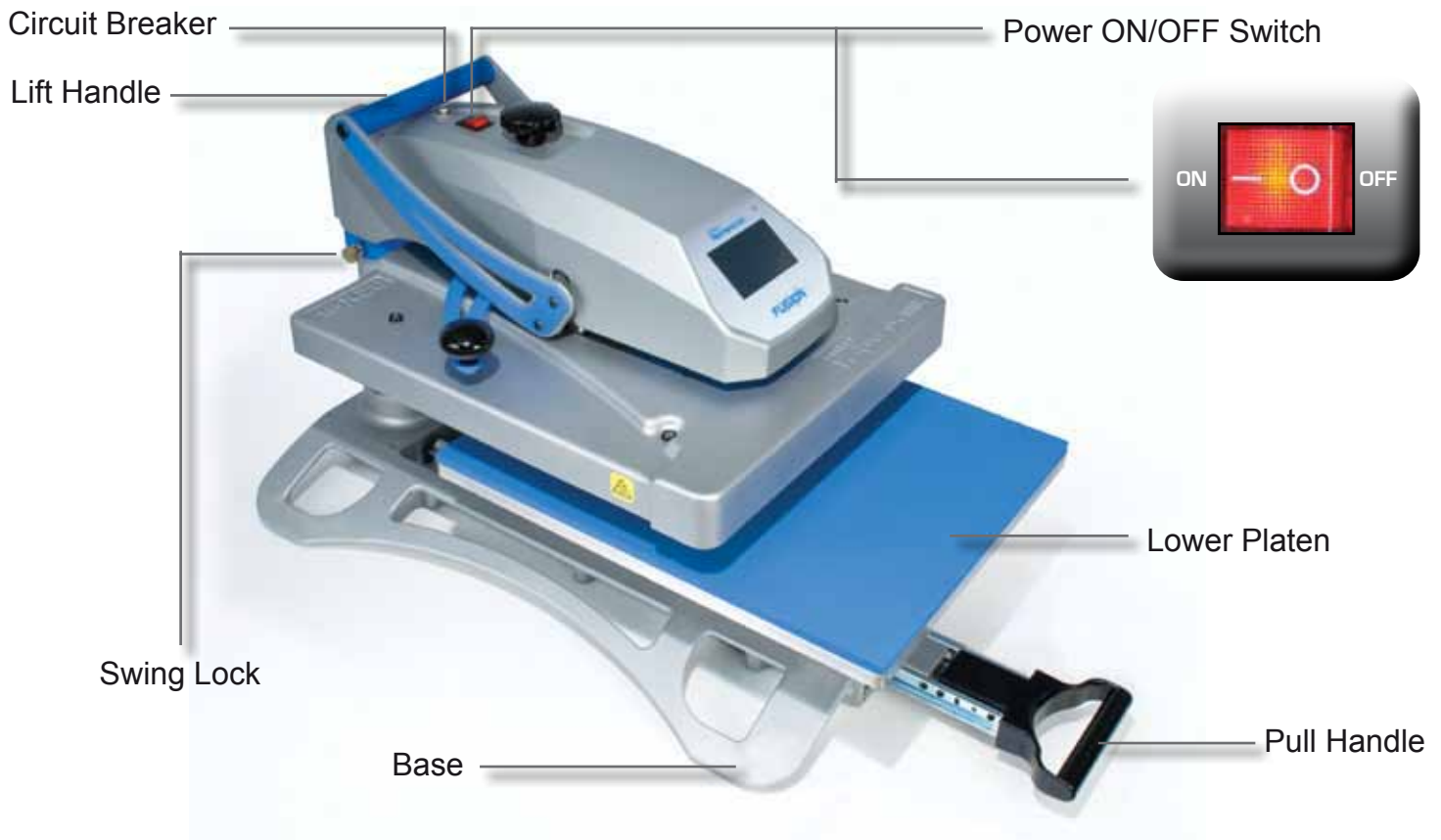
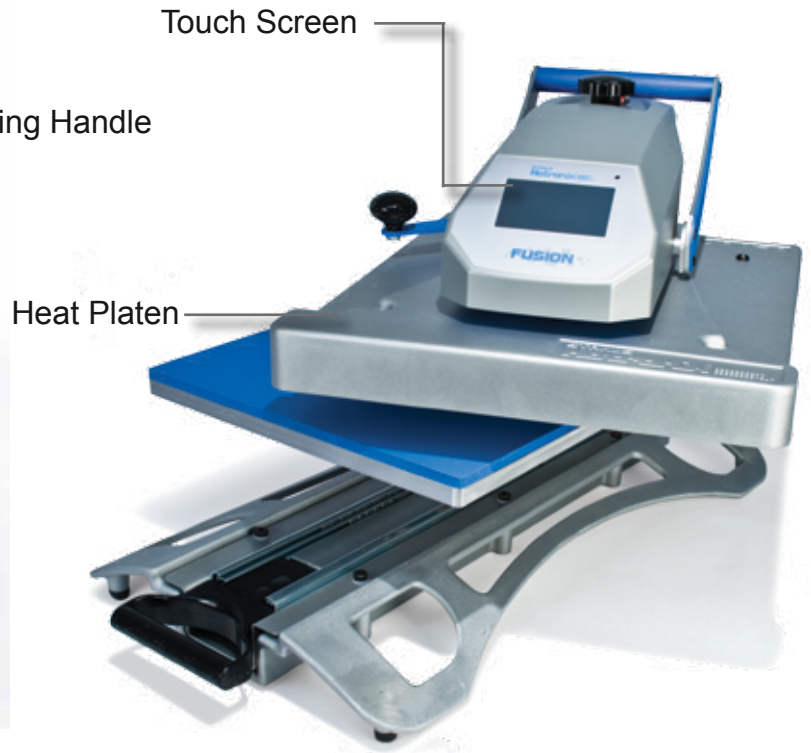
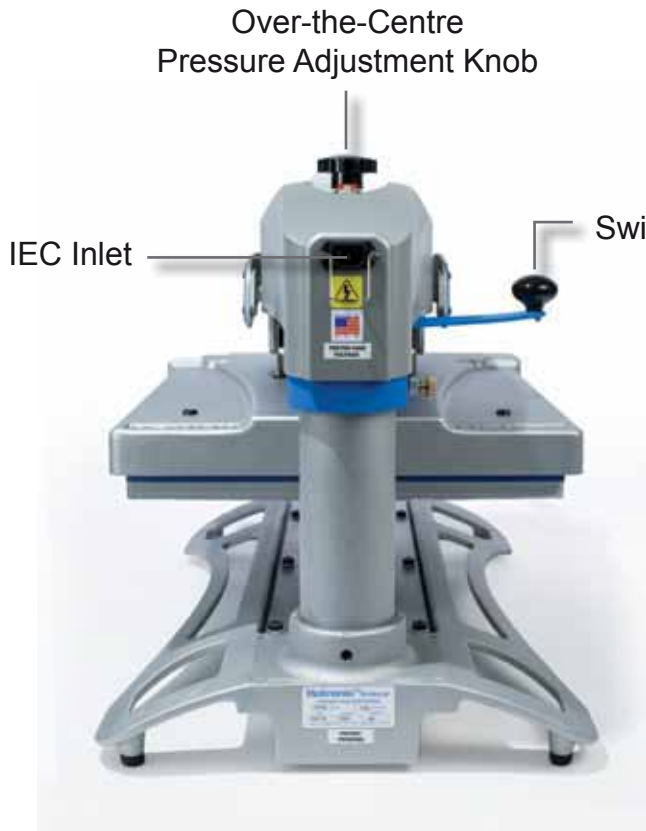

# Hotronix® Fusion Operation Instructions

The Hotronix® Fusion Operating Instructions are designed with the user in mind. Carefully read and follow the step-by-step instructions for best results.

- Work carefully and avoid contact to the hot heat plate, since this may cause serious burnings.
- During closing of the press, keep hands away from the hot plates (danger of bruises and burnings).
- Put the press onto a sturdy, non-slip and non wobble base. The press can also be screwed onto a sturdy base, it is specially prepared.
- On unpacking, please immediately check the heat press with regard to damage in transit. Before first use, allow the press to stand at room temperature for some hours in order to avoid condensation with subsequent possible short circuit.
- Handle the press standing in front of it, with both hands at the foam hand grips. The position of the machine should be adapted to user's height.
- The optimal operating conditions for your press are at a maximum humidity of 70 %, at an ambient temperature between + 15° C and +50° C.
- If a foreign object or liquid should get into the interior of the device, immediately grasp plug and pull to disconnect. A qualified service person has to check the device before re-use.
- During incorrect use or use of the device not as intended, material or personal damage could occur. The manufacturer assumes no liability.

## Connecting the System



Connect the power cord into a properly grounded (earthed) electrical outlet with a sufficient amperage rating.

240 Volt - The Hotronix® Fusion requires a full 10 amp grounded circuit for 240 volt operation.

Extension Cords: If used, should be as short as possible and not less than 12 gauge. Heavy duty cords are recommended.

Circuits: that have less than 15 amps or that have other high demand equipment or heat presses plugged in should not be used.

### NOTE:

If the supply cord is damaged, it must be replaced by the manufacturer or its service agent or a similarly qualified person in order to avoid hazard. Use HSJ type, rated 250 V - 10 AMP for replacement.

### CAUTION:

Failure to follow these instructions will cause:

1. Erratic controller functions.
2. Inaccurate displays and slow heat-up.
3. The circuit breaker to disengage.



## ■ Menu Selection Screen

A scrollable Menu Selection screen provides a quick and easy navigation to system operations. Use the Up/Down arrow buttons on the Menu Selection Screen to scroll through the available menus. The large menu button in the middle displays the selected menu. Press this Menu Button to choose the menu selection. The smaller top and bottom menu button displays the previous and next menu selections. (Fig.1)



Fig.1

## ■ Control Bar

Each screen has a control bar display at the bottom. This bar displays the current Date, Time and the Stahls' Hotronix® Logo.

## ■ Editing

Editable fields are displayed as text boxes with a white background. Selecting an editable field will display a Keypad that can be used to edit the field value. (Fig.2)

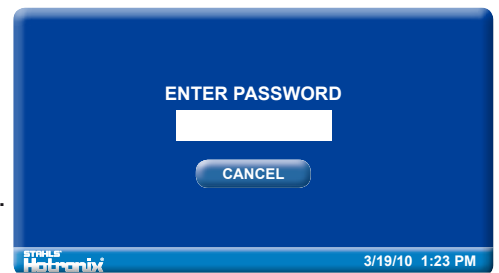

Fig.2

## ■ Increasing / Decreasing Values

In addition to editable fields, an Up/Down arrow button may be provided to increase or decrease values, or scroll through a list of values. The Up/Down arrow button (in most cases) can be held down to automatically increase or decrease the value. (Fig.3)



Fig.3

## ■ Navigation

Most screens have a Cancel or Back button to close the current screen without saving any changes and will return the user to the previous screen. (Fig. 4)

## ■ Keyboard / Keypad Display

The Keyboard/Keypad display is used for data entry purposes. The Keypad can be used to enter text or numeric data when required. It also provides function keys for Cancel, Enter, and Backspace/Clear (“<”) keys. Also a mode key may be present between the Cancel and Enter key. The mode key can switch between upper and lower case letters and numeric and other characters that maybe entered using the Keyboard/Keypad. Typically the current value is displayed in the Keypad value display at the top of the screen. Use the Keypad to change the current value. Use the Enter key to accept the change or the Cancel key to exit without accepting the change to the current value. The Keyboard/Keypad display is also used for password entry. Password characters will be displayed with “\*” in place of the password value. (Fig.5)



Fig.4

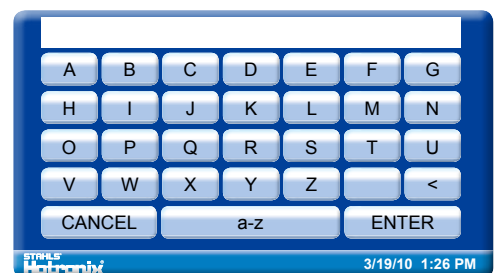

Fig.5

The Password is „U“.



## Start Up

### 2. To start up your Fusion™ Press:



2.1

Flip the Power switch to the “On” position. (The power switch is located on the top of the control housing). (2.1) During the startup, a splash screen is shown for approximately 3 seconds. This screen displays the Hotronix® logo and current software version information. (2.2)



2.2

## Shut Down

### 3. To shut down your Fusion™ Press:



3.1

Select the “Main Menu” button in the operation screen. (3.1)

Then select the “Shutdown” function in the Main Menu or flip the power switch to the off position. (3.2)



3.2



3.3

When the heat platen is above 100°F (38°C), the current platen temperature is displayed on a orange background as a warning of the current platen temperature. (3.3)



3.4

**NOTE:** During this time, the Shutdown operation can be exited by simply pressing the touch screen. The Dream Board will exit the Shutdown screen and return to the Main Menu.

Once the platen has cooled below 100° F (38° C), the touch screen will go blank. (3.4)

## Operation Screen

4. The Operation Screen is the first screen displayed after the splash screen and start up has completed. This screen provides all the printing functions.

### ■ Presets

Saved Presets are displayed at the top of the Operation screen. Presets can be selected using the Left and/or Right arrow keys at the top left and right corners of the screen. Only the left arrow key is displayed when only one Preset is present. The Preset displays the Time1(s), Time 2(s), Temperature(F) and Pressure(PR). (4.1)

The example shown depicts a Preset with the name of "New Preset 1", a first timer of 8 seconds, a second timer of 10 seconds, and a temperature of 330°F using a platen pressure of 5. (4.1)



4.1

### ■ Actual Readings

The Actual Temperature and Pressure readings are displayed on the left side of the Operation screen. These are the current Heat Press readings. (4.2)

### ■ Target Settings

Target Temperature and Timer settings are displayed on the right side of the screen. These settings may be overridden. (4.2)

To change these settings, select the Target Temperature and/or Timer display and adjustment Up/Down arrows will be displayed. Use the Up/Down adjustment arrows to change the Target Temperature and/or Timer. (4.3)

The Preset display name at the top of the screen will change to "Override" to indicate the Preset has been manually changed. (4.3)

### Note:

During the print process, the Target Timer setting will change to display a count down timer showing the remaining time on the printing process.



4.2

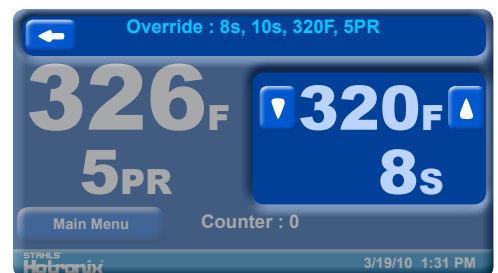

4.3

### ■ Job Counter

A Job Counter is displayed in the bottom middle of the screen. The Job Counter counts the total number of complete print cycles performed using the current Preset or Override settings. Exiting the Operation screen or changing the Preset will reset the Job Counter to 0. Changing an Override setting does not reset the Job Counter to 0. (4.4)



4.4

### ■ Main Menu Button

Use the Main Menu button to exit the Operation screen and proceed to the Main Menu. (4.4)



## Main Menu

5. The Main Menu provides access functions of the Fusion™ product. The available menus are: Shutdown, Setup, About, and Operation.



5.1

Select the “Operation” Menu to exit the Main Menu and return to the Operation screen. (5.1, 5.2)



5.2



5.3

Select the “About” Menu to display the Splash Screen. The Splash screen is displayed for approximately 3 seconds and returns to the Main Menu selection screen. This menu is useful for displaying the current software version and production information. (5.3, 5.4)



5.4



5.5

The “Setup” Menu selection screen provides additional system setup functions not accessible from the Main Menu. Those functions are: Presets, Display, Auto On/Off, and Main Menu. (5.5, 5.6)



5.6

**Note:** A Password is required to access the Setup menu. (refer to pgs 10 -11 for Login information)



5.7

Press the “Shutdown” menu to exit The Fusion™. (5.7, 5.8)



5.8

See page 7 for further details.

## Passwords

6. A password is required to access the Setup Menu and configure certain functions of the Hotronix® Fusion™.



6.1

In the Main Menu, press the "Setup" Menu. (6.1)

Then press the blank password field. (6.2)

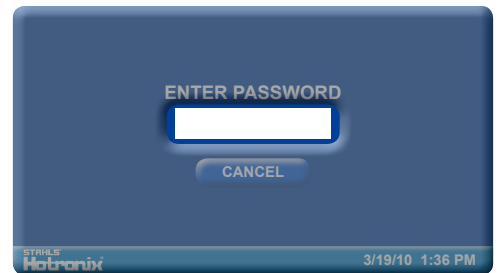

6.2



6.3

A Keyboard/Keypad will be displayed. (6.3)

Enter the letter "U" for a "User Level" password and press Enter when complete. (6.4)

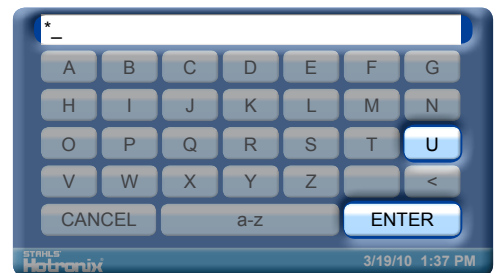

6.4



6.5

### Note:

You can Select the Cancel button to exit the Password Entry screen and return to the previous screen at any time. (6.5)

If an invalid password is entered, select the blank password field and repeat the previous step. (6.6)

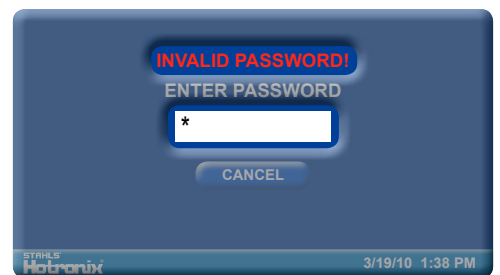

6.6



6.7

Now you will be automatically entered into the Setup Menu where you will have full access to all Setup functions. (6.7)



6.8

## Display Setup

7. The Hotronix® Fusion™ functions and features can be configured using the Setup menu.

These features include:

Presets, Display, Auto On/Off, and Main Menu.

After your password is entered in the setup menu, scroll down and select the “Display” button. (6.8)

This option will allow you to configure the Temperature Units, Pressure Units, Display Language and to set the Date and Time. (7.1)

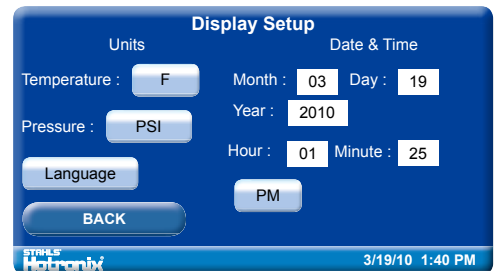

7.1

### ■ Temperature Units

The Temperature Units can be changed from F (Fahrenheit) to C (Celsius). This is a global setting and Temperature values will be displayed in the configured units. Select the Temperature Units button to toggle between “F” and “C.” Press the Save button to save any changes. (7.2)

#### Note:

You will lose any changes if you leave the Setup Menu without pressing the “Save” button. You can also use the “Back” or “Cancel” buttons on Setup Screens to exit the screen and return to the previous screen.

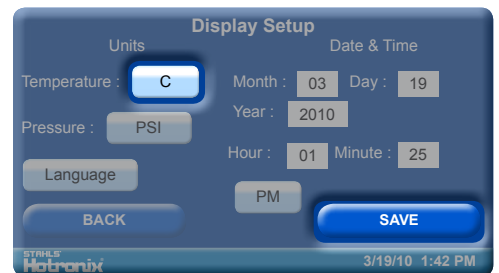

7.2

### ■ Pressure Units

The Pressure Units can be changed from PSI (Pressure per Square Inch) to kPa (kilopascals). Select the Pressure Units button to toggle between PSI and kPa. These are your global pressure settings that will be displayed in the configured units. Press the Save button to save any changes. (7.3)



7.3

### ■ Language

Language selection screen will be displayed. Use the Up/Down arrows to scroll through the available languages. Once the desired language is selected, press the “Save” button. (7.4)

#### Note:

Changing and Saving the Language setting requires a restart of the Fusion™. The machine will automatically restart and return to the Operation screen using the new Language display settings.



7.4

Please refer to page 11 to configure the Date and Time.

## Display Setup

### ■ Date and Time

To set the Date and Time, select the individual numeric display for the Month, Day and Year. A numeric Keyboard/Keypad will be displayed. (7.5)

Change the numeric value using the Keypad, then press “Enter” to save any changes.

Repeat the same process to set the Hour and Minute.

To change the AM/PM designator, select the AM/PM button to toggle between the AM/PM settings. (7.6)

Press the Save button to save the new Date and Time settings.

#### Note:

It may take a few seconds for the Date and Time display to update on the Control Bar at the bottom of the screen.

Select the back button to return to the Setup menu. (7.6)

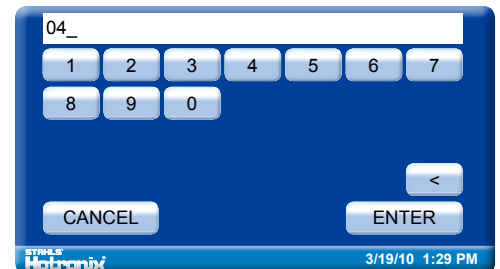

7.5



7.6

## Auto On / Off Setup

8. The system can turn On or Off automatically when configured. The Auto On/Off feature is configured for each day of the week.

- In the Setup Menu, Select the Auto On/Off Button. To configure an Auto On/Off setting, use the Up/Down selection arrows to select the day of the week to be configured. Use the Enable/Disable button to enable that day of the week setting. (8.1)

#### NOTE:

Each day that you want the system to automatically turn On/Off, must be Enabled.

- When enabled, set the time of day for Auto On and Off events by selecting the Hour and Minute fields. (8.2) Using the displayed Keyboard/Keypad, enter the numeric time values and press enter. Use the AM/PM designator button to toggle between the AM or PM settings. Select the Save button to save the settings. (8.2)

#### NOTE:

Selecting another day of the week or exiting the Auto On/Off Setup screen without saving will result in loss of changes.

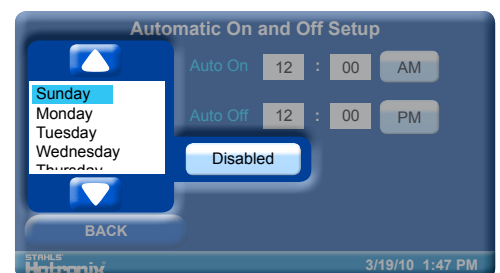

8.1

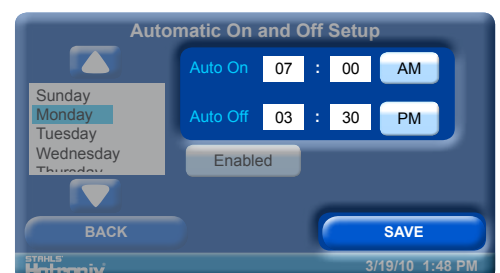

8.2

## Presets Setup

9. Presets are configured using the Preset Setup screen. A Preset can have 1 - 4 Timer values, 2 Temperature values, 1 Platen Pressure setting, and a descriptive Name.



9.1

In the Setup Menu, Select the “Presets” button. (9.1)

Use the Up/Down arrows to scroll through the list of Presets and select a Preset for editing. (9.2)

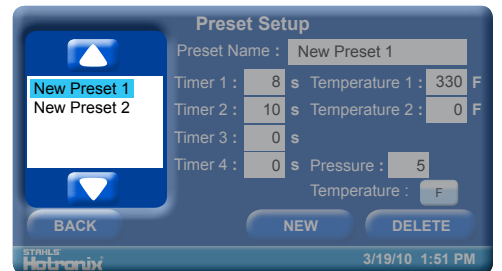

9.2

### ■ Preset Name

A descriptive name for identifying a Preset, limited to 20 characters in length. A Preset Name can be added to the Preset list by selecting the “New” button. (9.3)



9.3



9.4

Enter a Preset Name by pressing the “Preset Name” field. (9.4)

A keyboard/Keypad will be displayed. Name the Preset and press “Enter.” (9.5)

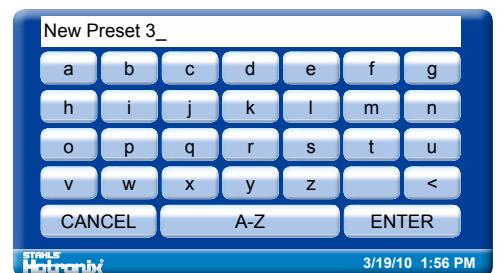

9.5

### ■ Press the “Save” button to save the new Preset. (9.6)

#### Note:

The new Preset must be Saved before it can be displayed in the list. Also, any changes to a Preset must be Saved before selecting a new Preset in the list and before exiting the Preset Setup screen or any changes will be lost.

Press the Delete button if you wish to remove any selected Preset from the list. (9.6)



9.6

**Note:** This function cannot be undone.

## Presets Setup

### ■ Timer

Timers can be set using values 0 – 999 seconds. Entering a value of 0 seconds disables a Timer and it will not be used or displayed in the Preset selection on the Operation screen.



9.7

Select the “Timer” field (Timer 1, 2,3 or 4) to open a Keyboard/Keypad to change the Timer setting. (9.7)

Select the desired time and press “Enter”. (9.8)

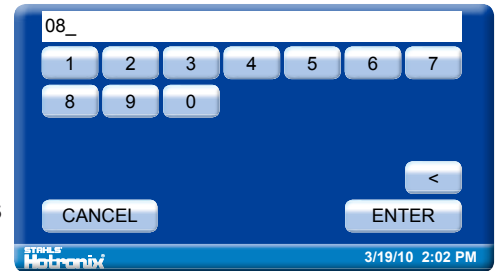

9.8

### ■ Temperature

Temperatures can be set from 32°F - 430°F (0° - 221°C). Setting a Temperature value to 0 (Fahrenheit) disables the Temperature setting. Select the Temperature field to open a Keyboard/Keypad to change the Temperature settings. (9.9)



9.9

Use the Temperature F or C button to toggle the Temperature units for display and/or entry between Fahrenheit and Celsius. (9.9)

Select the desired temperature and press “Enter”. (9.10)



9.10

### ■ Pressure

This is the recommended Preset Platen Pressure setting. This has a valid range of 0 - 9. A “0” Pressure readout would indicate no pressure at all and “9” would indicate very heavy pressure.



9.11

Select the Pressure field to display a Keyboard/Keypad for editing this value. (9.11)

Select the desired pressure and press “Enter.” (9.12)



9.12



# Operating Instructions

## Printing / Pressing

### 10. PREPARE TO PRINT

To begin Printing / Pressing, go to the Main Menu and select “Operation” to enter the Operation screen. (10.1)

**Note:** Be sure you have the correct Preset selected for your application.



10.1

You may also manually adjust your desired Time, Temperature and Pressure settings (refer to page 8).

**Note:** Be sure the Actual press Temperature has reached the Target Temperature. (10.2)

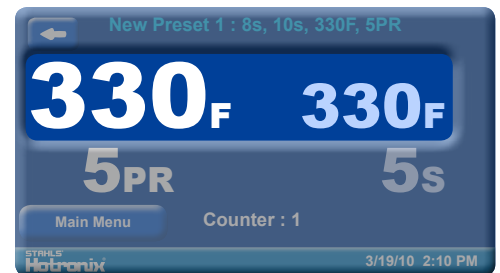

10.2

When the desired settings are reached you may begin to Print / Press.



10.3

When using the “Swing” feature: Swing the heat platen out and position the garment and application. (10.3)

When using the “Draw” feature: Pull out the lower platen and position the garment and application. (10.4)



10.4

Swing the heat platen or push the lower platen back into position. Then lower the heat platen into the press position.

The Timer display will automatically initiate a count down and visually and audibly signal you when to lift the platen off the garment. Immediately lift the platen to the UP position. (10.5)

Swing the heat platen or pull the lower platen away and proceed according to your application’s instructions.

Your equipment has automatically reset and you may continue to Print / Press.

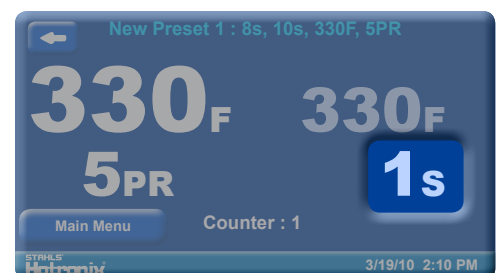

10.5

# Replacement Part List

Item #	Part Name	Part #	Qty.
1	Base Assembly	4-1175	1
2	Rubber Foot	1-2199	4
3	Right Upper Link	Kit 3-6929	1
4	Low Profile SHCS	3-1011-245	2
5	Stop Collar	1-2203	1
6	Hex Nut	2-1006-93	1
7	Hand Retractable Plunger	1-2206	2
8	Steel Pin	1-2204	1
9	Upper Casting	2-1664	1
10	Washer	2-1006-21	1
11	Castle Nut	2-1006-1	1
12	Adjustment Casting	1-2162	1
13	E-Clip	1-1019-1	1
14	Steel Shim	1-2217	1
15	Adjustment Spindle	1-1010-2	1
16	Adjustment Knob	1-1012	1
17	Spherical Washer	2-1006-92	1
18	Ball Plunger	1-2201	1
19	Roll Pin	1-1018-1	2
20	Swing Knob	1-1054	1
21	Lift Rod Bushing	1-1013	1
22	Left Upper Link	Kit 3-6929	1
23	Guide Tube	1-2194	1
24	Undercarriage	Kit 3-6911	1
25	Handle Spacer	0175-12	1
26	Foam Grip	1-2116	1
27	Lift Link	1-1024	2
28	Clevis Pin	1-1017-1	2
29	Nylon Lock Nut	2-1006-20	2
30	Screw, Cap But Hd. 3/8-16 x 3/4"	3-1011-244	3
31	Inner Lift Arm (Thick)	1-2207	2
32	Bearing	1-1300	2
33	Outer Lift Arm (Thin)	1-2208	2
34	C-Frame	3-1335	1
35	Slide Rail	1-1749	2
36	Draw Tray	1-2164	1
37	Compression Spring	1-2195	6
38	Nylon Washer	2-1006-65	6
39	Shoulder Bolt	3-1011-121	6
40	Draw Handle	1-2182	1
41	Quick Change Pin	1-2215	1
42	Adaptor Plate	3-1336	1
43	Lower Platen	2-1029	1
44	Silicone Pad 16"x20" (Blue)	1-2136	1
45	Heat Platen (16"x20")	2-1002	1
46	Heater Cover	1-2189	1
47	Finish Washer	1-1063	4
48	Cover Screw	3-1011-217	4
49	Touch Screen Controller	1-2167	1
50	Control Housing Overlay	1-2198	1
51	Control Housing	1-2197	1
52	Power Switch	1-2087	1
53	Breaker	1-1331	1
54	IEC Inlet	1-1759	1
55	Power Coard	2-1013-1	1

# Hotronix® Fusion Parts Location Guide

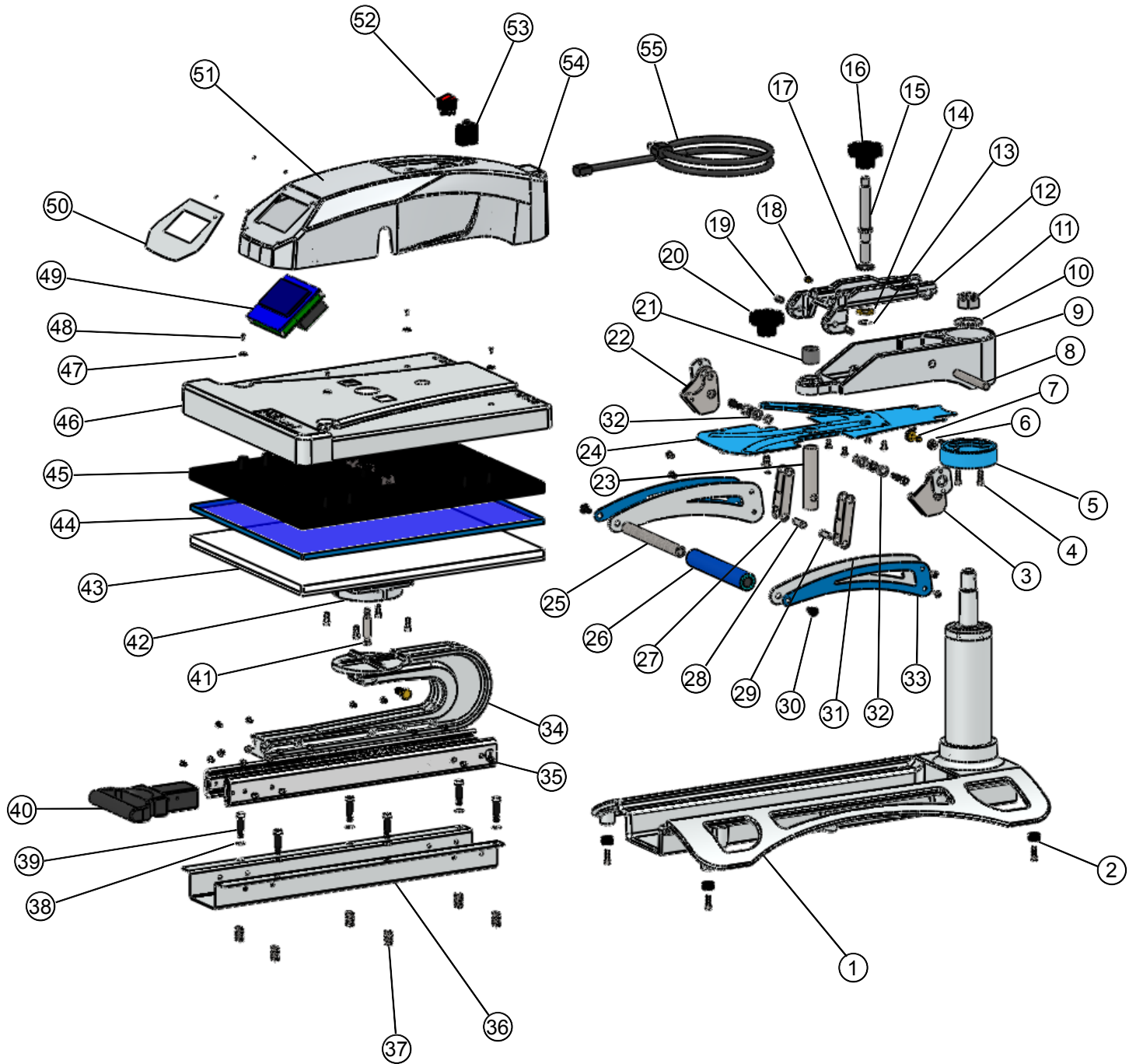

# Hotronix® Fusion Electrical Schematic

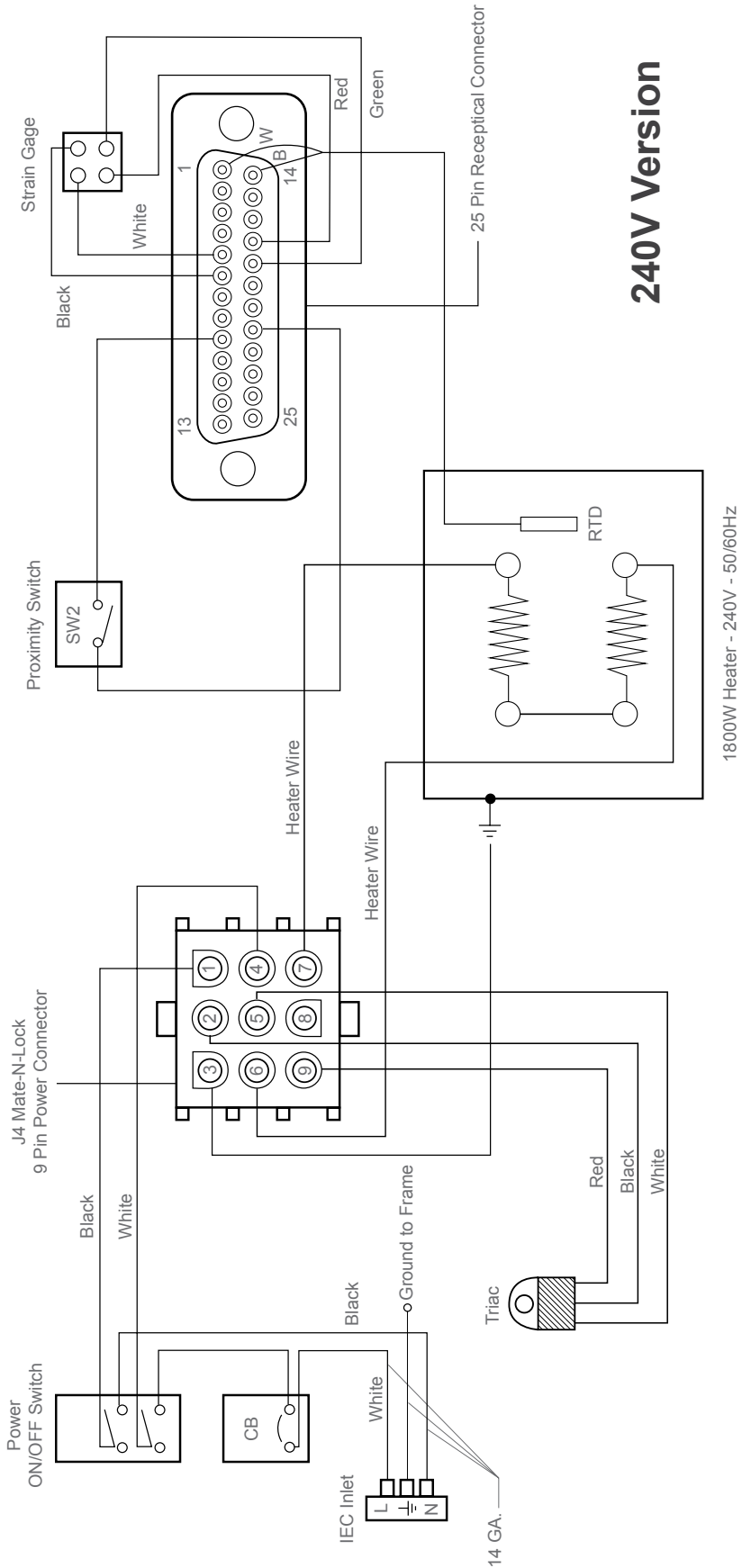

**240V Version**

**EC conformance explanation:**

For the purposes of the EC-Machine Guideline 98/37EU, Appendix 2A and the EC Low Voltage directive to 73/23 European Economic Community as well as the EC EMV-guideline 89/336. For the manufacturer STAHL'S' Hotronix Division, we state as European Commissioners, that our product:

A Transfer Press for ironing of thermo application.

Model: Maxx™ Clam

The product supplied corresponds to the following appropriate regulations:

EMC Directive (2004/108/EC) & Low voltage Directive (2006/95/EC)

Applied Harmonized norms

EN 55011:2007	EN 61000-4-2:1995	EN 61000-4-6:1996
EN 61000-3-2:2006	EN 61000-4-3:2006	EN 61000-4-8:1993
EN 61000-3-3:1995	EN 61000-4-4:2004	EN 61000-4-11:2004
EN 61000-6-1:2007	EN 61000-4-5:2006	
IEC 60335-1:2001	IEC 60335-2-44:2001	



It is possible that not all the listed norms apply to the above mentioned product.

STAHL'S' Europe GmbH

(Frank Brücker, Chief Executive STAHL'S' Europe GmbH)

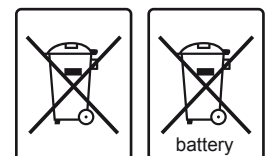

**WEE and RoHS Symbols**

STAHL'S' Europe GmbH will take back ALL heat press machines FREE OF CHARGE (inside the EU) that have been manufactured by them, even those sold prior to the date stated above, subject to the heat press machine being delivered to them at the owners costs.

STAHL'S' Europe GmbH will break down the heat press machine and ensure that all recyclable parts are correctly recycled, and non-recyclable parts will be disposed of in accordance with legal requirements. In an effort to make such transaction as smooth to customers as is possible, and to ensure that all STAHL'S' heat presses are identifiable, all heat press machines supplied by STAHL'S' Europe GmbH will have the logo/brand of STAHL'S' Hotronix clearly marked upon them.

*Contact:*

STAHL'S' Europe GmbH, Dieselstraße 62, 66763 Dillingen, Germany

Telefon: +49 (0) 68 31/97 33-0, Fax: +49 (0) 68 31/97 33 45, [www.stahls.de](http://www.stahls.de), [info@stahls.de](mailto:info@stahls.de)

## Warranty Policy

STAHL'S Europe GmbH provides the following warranty for the Hotronix® Fusion, subject to the following terms:

### Duration

The warranty period of 2 years commences from the date of receipt by the buyer of the heat press machine, which can be verified by the invoice or similar documents. The warranty does not cover any damage caused by normal wear and tear.

### Repair

If any parts are found to be defective, despite proper use, authorised use and not as a result of fair wear and tear, within the warranty period, then they will be replaced or repaired without question provided that STAHL'S Europe GmbH have been informed of any such claim in writing within one week of the occurrence of the failure. The terms and conditions of the commercial transaction are specifically excluded from this warranty, especially §§377 et.seq. HGB. Following any claim under the warranty, the warranty period will not be extended for either the heat press machine or for any replaced parts. Any exchanged parts will be the property of STAHL'S Europe GmbH. No charge will be made for any labour or components for any claim under the warranty. STAHL'S Europe GmbH operates a "bring in" guarantee for the first six months from the date of the purchase, under which all delivery and return costs will be borne by STAHL'S Europe GmbH. After the first six months from the date of purchase, all delivery and return costs will be borne by the customer.

### Rectification

Initially the customer's rights are limited to repair by STAHL'S Europe GmbH. Should the repair or remedial works finally fail, it will become the customer's right according to §462 BGB to receive a payment reduction, or to withdraw from the contract. In every case, any further claim would be excluded, especially indemnity claims (including consequential damages) and those resulting from defects, unless it can be proven that STAHL'S Europe GmbH acted intentionally, grossly negligently, or there are requirements according to §463 BGB.

### Returns

Goods may only be returned with express written authorisation from STAHL'S Europe GmbH. Customers must ensure that the heat transfer machine is properly fixed to the supplied wooden panel, and returned in the original carton, which must include the contact details of the sender, together with details of any failure which requires remedying. STAHL'S Europe GmbH will not be liable for any damages howsoever caused during transportation as a result of improper packaging.

### Acceptance of Returned machines manufactured by STAHL'S for disposal

STAHL'S Europe GmbH agrees to accept the return of all heat press machines manufactured by STAHL'S or with their genuine trademark for Free of Charge disposal, subject to the costs of delivery to STAHL'S Europe GmbH being borne by the sender. WEEE DE 54539730.

### Packaging

The original carton (box), packaging and wooden transport panel must be retained for any future transportation of the heat press machine.

### Circuit Breaker

If the circuit breaker should become dislodged, it can easily be reinstated after the heat press machine has cooled down. It is recommended to try and eliminate the source of any failure by using the error checklist.

### Set Up

It is important that the heat press machine is fixed securely to your worktop. To set up the press, it is necessary to fully open the press, and place the substrate that is to be printed flat on the lower platen. If the press is not fully open, there is a risk of being burnt. Always follow the supplied instructions for printing for every respective material.